

AHU *type*

High Feed end mill AHU



MOLDINO Tool Engineering, Ltd.

New Product News | No.1210E-10 | 2022-11

Technology

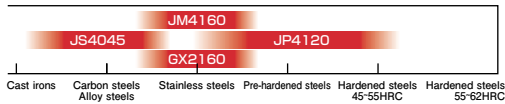

Applications

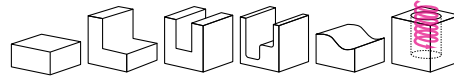

Features and Applications

- AHU has the outstanding sharpness and toughness.
- Evolved into the multi-function tool in which a ramping operation is possible.
- Enlarging the range of applications. Especially, AHU is suitable for turbine-blade machining.

It is lineup about two series by cutting edge length.

AHU(L)10 type Multi-flute type for low depth of cut.

AHU(L)15 type High rigidity type for high depth of cut.

Cutting force is reduced by high rake geometry.

Ramping operation is possible.

Cutting Dia.
=Shank dia. +1mm type is standardized.

30% increased rigidity compared with conventional by using special steel and chip pocket geometry.

Coolant through is available.

Increasing tool life and suitable for high speed cutting by new substrate and coating.

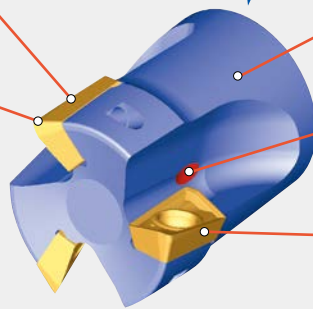

Repatory

AHUL1021R-3
AHUL1026R-3

Recommended grades map

Insert cross-section	Low cutting force edge shape → Tough cutting edge shape				
	Sharp edge	Positive land (Large rake)	Positive land (Small rake)	General purpose	Tough cutting edge
	FA type	B5/B7 type	C5/C7 type	FW type, FF type, Conventional	TFW type
Application	Aluminum use	Stainless steel materials Titanium alloy, Nickel-based alloy	Stainless steel materials Nickel-based alloy	General Breaker	Forged surface cutting; Strong intermittent cutting
Mild steels, Carbon steels Alloy steels, Die steels	—	—	JP4120	JS4045 JS4060	JS4060
Pre-hardened steels (30~40HRC)	—	—	—	JP4120	JP4120
Stainless steels	—	JM4160(Wet) JP4120(Semi finishing)	GX2160(Dry)	JM4160(PTH30E)	JM4160
Cast irons	—	—	—	PTH13S(JP4120)	—
Aluminum alloys	WH10 SD5010	—	—	HD7010 (Cast aluminum alloy material)	—
Titanium alloys	—	JP4120	—	PTH30E	—
Nickel-based alloys	—	(JM4160) (ST treatment)	JP4120 (AG treatment)	—	—

New inserts are added for difficult-to-cut materials. Newly appear two kind of breakers



B5/B7 type breaker

High-rake
low-cutting force breaker

For cutting of stainless steel materials, machining of titanium alloys, and cutting of nickel-based alloys.

Features 1

- Achieved low cutting force by larger axial rake angle

Conventional Insert :
15 degrees

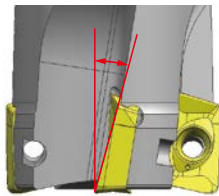

New breaker B/C type:
18 degrees

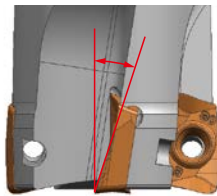

C5/C7 type breaker

Mildly-raked
low-cutting-force breaker

For machining of stainless steel materials and machining of nickel-based alloys.

Features 2

- The cutting flute length is shortened to suppress chattering vibrations during slotting, etc.

10Type APMX=5mm

15Type APMX=7mm

For 10 type, APMX=5mm.

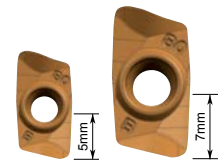

When using B5/C5 or B7/C7 breakers, there are restrictions on APMX. Please use after checking machining conditions beforehand.

Comparison of cutting force

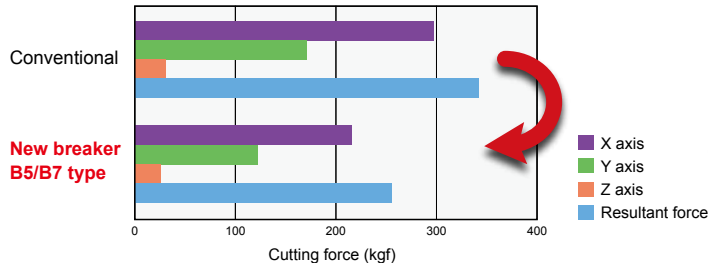

Cutting force is reduced by 25% compared to conventional breakers!

Features of AJ Coating series

- Employs an AlTiN layer with a new composition created by increasing the Al content of conventional layers.
- Excellent wear resistance, chipping resistance, and heat resistance!

New technology!!

- The new layer with high Al content employs a new composition and optimizes the structure to improve wear resistance and chipping resistance!
- Employs a low-friction-effect coating with excellent welding resistance as the top-most surface layer. This reduces welding to the work and decreases cutting force!

Layer structure AJ Coating

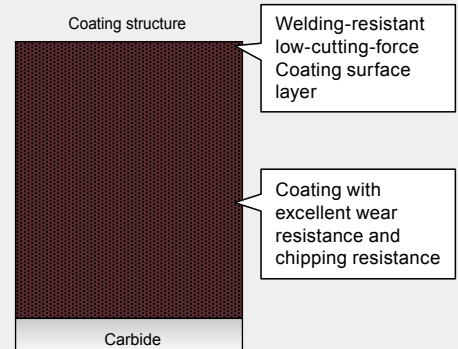

PVD Technology

Grade for machining pre-hardened or hardened materials **JP4120**

Features

- Employs a fine carbide substrate with an excellent balance between wear resistance and toughness and the new "AJ Coating" to provide improved wear resistance and chipping resistance.
- Highly versatile with excellent wear resistance and chipping resistance when machining steel materials with hardnesses of 30 to 50 HRC.

Strong fields

- Exhibits excellent cutting performance when machining pre-hardened or hardened steel with hardnesses of 30 to 50 HRC.
- Exhibits excellent wear resistance even on difficult-to-cut diecast tool steel or precipitation-hardened stainless steels, or for finishing.

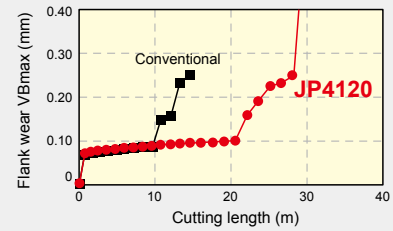

Work material : P21(40HRC)
 Tool : AHU1532R-3
 Insert : JDMT150508R
 Cutting conditions :
 $V_c=120\text{m/min}$, $f_z=0.15\text{mm/t}$
 $a_p \times a_e=3 \times 10\text{mm}$, Dry
 ※Single-flute cutting

PVD Technology

Grade for machining stainless-steel materials **JM4160**

Features

- Employs a carbide substrate with high toughness and the new "AJ Coating" to improve wear resistance and chipping resistance when machining stainless-steel materials.
- Employs AJ Coating with excellent welding resistance to reduce the welding to work material that occurs when machining stainless steel materials.

Strong fields

- Provides long tool life for general processing of stainless-steel materials

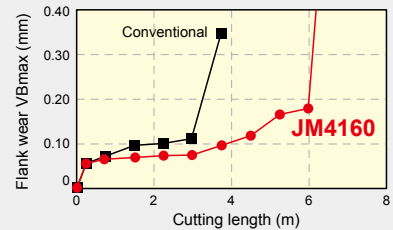

Work material : SUS630 (35HRC)
 Tool : AHU1532R-3
 Insert : JDMT150508R
 Cutting conditions :
 $V_c=120\text{m/min}$, $f_z=0.12\text{mm/t}$
 $a_p \times a_e=3 \times 5\text{mm}$, Dry
 ※Single-flute cutting

PVD Technology

General purpose for steel **JS4045**

Features

- JS4045 adopts heat resistant layer, reduces the crater wear by high-speed cutting.
- JS4045 adopts heat resistant substrate, reduces the wear and improves tool life.
- Improves tool life on dry cutting.

Strong fields

- continuous and light interrupted cutting of less than 35HRC dry cutting.

Layer structure JS Coating

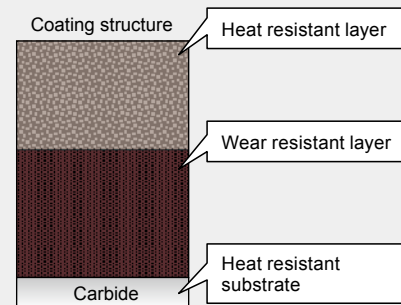

CVD Technology

Grade for processing stainless-steel materials **GX2160**

Features

- Increasing the fineness of the membrane's columnar structure improves wear resistance.

Strong fields

- Adopt CVD coating with excellent heat resistance improves wear resistance and provides long life when dry-cutting stainless steel materials.

Layer structure GX Coating

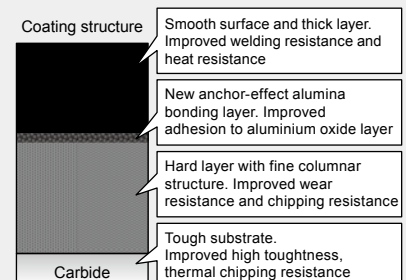

Line Up

Shank type

AHU (L) ○○○○R-○

Numeric figure in a circle ○.

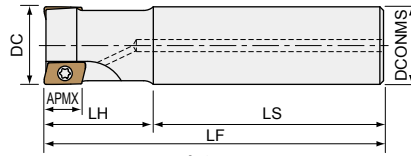

A type
(Standard type)

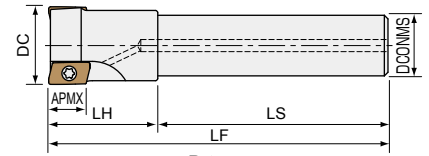

B type
(Undercut type)

Item code	Stock	No. of flutes	Size(mm)						Shape	Inserts	
			DC	LF	APMX	LH	LS	DCONMS			
Regular shank type	AHU1016R-2	●	2	16	100	9 (5)*	30	70	16	A	JDMT1003○○○R
	AHU1020R-3	●	3	20	110		30	80	20	A	JDMT1003○○○R-FW
	AHU1025R-4	●	4	25	120		35	85	25	A	JDMT1003○○○R-B5/C5*
	AHU1030R-5	●	5	30	120		45	75	32	A	JDET1003○○○R-FF
	AHU1032R-5	●	5	32	130		45	85	32	A	JDET100304R-FA
	AHU1525R-2	●	2	25	125	14 (7)*	40	85	25	A	JDMT1505○○○R
	AHU1530R-2	●	2	30	130		45	85	25	B	
	AHU1532R-3	●	3	32	140		45	95	32	A	JDMT1505○○○R-FW
	AHU1535R-3	●	3	35	140		45	95	32	B	JDMT150508R-TFW
	AHU1540R-2	●	2	40	140		45	95	32	B	JDMT1505○○○R-B7/C7*
	AHU1540R-3	●	3	40	140		45	95	32	B	JDET1505○○○R-FF
	AHU1540R-4	●	4	40	140		45	95	32	B	JDET1505○○○R-FA
AHU1550R-3	●	3	50	140	45		95	32	B	JDET1505○○○R-FA	
AHU1550R-5	●	5	50	140	45		95	32	B		
AHU1550R-5	●	5	50	140	45		95	32	B		
Long shank type	AHUL1016R-2	●	2	16	150	9 (5)*	50	100	16	A	JDMT1003○○○R
	AHUL1020R-2	●	2	20	160		60	100	20	A	
	AHUL1020R-3	●	3	20	160		60	100	20	A	
	AHUL1021R-3	●	3	21	160		30	130	20	B	
	AHUL1025R-2	●	2	25	180		75	105	25	A	
	AHUL1025R-3	●	3	25	180		75	105	25	A	
	AHUL1026R-3	●	3	26	180		35	145	25	B	
	AHUL1030R-2	●	2	30	180		45	135	25	B	
	AHUL1030R-3	●	3	30	180		45	135	25	B	
	AHUL1032R-4	●	4	32	200		90	110	32	A	
	AHUL1035R-2	●	2	35	200	45	155	32	B		
	AHUL1035R-4	●	4	35	200	45	155	32	B		
	AHUL1525R-2	●	2	25	180	14 (7)*	75	105	25	A	JDMT1505○○○R
	AHUL1530R-2	●	2	30	180		45	135	25	B	
	AHUL1532R-3	●	3	32	200		90	110	32	A	
	AHUL1535R-2	●	2	35	200		45	155	32	B	
	AHUL1535R-3	●	3	35	200		45	155	32	B	
	AHUL1540R-2	●	2	40	220		45	175	32	B	
	AHUL1540R-3	●	3	40	220		45	175	32	B	
	AHUL1540R-4	●	4	40	220		45	175	32	B	
AHUL1540R-5	●	5	40	220	45		175	32	B		
AHUL1550R-4	●	4	50	220	45		175	42	B		

[Note] * The APMX in the case of using JDMT1003○○○R-B5/C5, JDMT1505○○○R-B7/C7 is a value shown in ().

Parts

Numeric figure in a circle ○.

Parts	Clamp screw	Driver	Wrench	Screw anti-seizure agent	
Cutter body					
					Shape
AHU (L) 1016R-2	250-141	1.1	104-T8	—	
AHU (L) 1020R-○~1035R-○	251-141	1.1			
AHU (L) 15○○○R-○	412-141	2.9	104-T15	—	
AHUB1550R (M)-3~1563R (M)-3			—	105-T15	P-37
AHUB1550R (M)-5~1563R (M)-6					
AHUB1580R-4					
AHUB1580R-7					
AHUB15100R-8					
AHUM10○○○R-○(-M○○○)	250-141	1.1	104-T8	—	
AHUM15○○○R-○(-M○○○)	412-141	2.9	104-T15	—	

* The clamp screw is a consumable part. Since replacement life depends on the use environment, it is recommended that it be replaced at an early stage.

● : Stocked Items.

Line Up

Modular Type

AHUM $\bigcirc\bigcirc\bigcirc\bigcirc$ R- \bigcirc (-M $\bigcirc\bigcirc$)

Numeric figure in a circle \bigcirc .

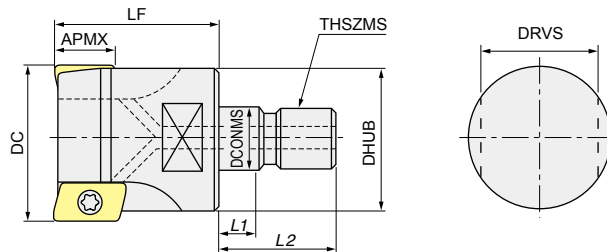

Item code	Stock	No. of flutes	Size(mm)									Inserts
			DC	LF	APMX	DCONMS	THSZMS	DHUB	L1	L2	DRVS	
AHUM1016R-2	●	2	16	25	9 (5)*	8.5	M8	12.8	5.5	17	10	JDMT1003 $\bigcirc\bigcirc$ R JDMT1003 $\bigcirc\bigcirc$ R-FW JDMT1003 $\bigcirc\bigcirc$ R-B5/C5* JDET1003 $\bigcirc\bigcirc$ R-FF JDET100304R-FA
*1 AHUM1018R-2	●	2	18	25		8.5	M8	14.5	5.5	17	10	
*1 AHUM1020R-2-M8	●	2	20	25		8.5	M8	14.5	5.5	17	10	
AHUM1020R-3	●	3	20	30		10.5	M10	17.8	5.5	19	15	
*1 AHUM1022R-3	●	3	22	30		10.5	M10	17.8	5.5	19	15	
*1 AHUM1025R-2-M10	●	2	25	30		10.5	M10	17.8	5.5	19	15	
AHUM1025R-4	●	4	25	35		12.5	M12	20.8	5.5	22	17	
*1 AHUM1028R-4	●	4	28	35		12.5	M12	23	5.5	22	17	
*1 AHUM1030R-2-M12	●	2	30	35		12.5	M12	23	5.5	22	17	
AHUM1030R-5	●	5	30	40		17	M16	28.8	6	23	22	
AHUM1032R-5	●	5	32	40		17	M16	28.8	6	23	22	
*1 AHUM1035R-2	●	2	35	40		17	M16	28.8	6	23	22	
*1 AHUM1035R-5	●	5	35	40		17	M16	28.8	6	23	22	
*1 AHUM1040R-6	●	6	40	40		17	M16	28.8	6	23	22	
AHUM1525R-2	●	2	25	35	14 (7)*	12.5	M12	20.8	5.5	22	17	JDMT1505 $\bigcirc\bigcirc$ R JDMT1505 $\bigcirc\bigcirc$ R-FW JDMT150508R-TFW JDMT1505 $\bigcirc\bigcirc$ R-B7/C7* JDET1505 $\bigcirc\bigcirc$ R-FF JDET1505 $\bigcirc\bigcirc$ R-FA
*1 AHUM1528R-2	●	2	28	35		12.5	M12	23	5.5	22	17	
*1 AHUM1528R-3	●	3	28	35		12.5	M12	23	5.5	22	17	
*1 AHUM1530R-2-M12	●	2	30	35		12.5	M12	23	5.5	22	17	
AHUM1530R-3	●	3	30	40		17	M16	28.8	6	23	22	
AHUM1532R-3	●	3	32	40		17	M16	28.8	6	23	22	

- [Note] ①* The APMX in the case of using JDMT1003 $\bigcirc\bigcirc$ R-B5/C5, JDMT1505 $\bigcirc\bigcirc$ R-B7/C7 is a value shown in ().
 ②Slotting by AHUM $\bigcirc\bigcirc\bigcirc\bigcirc$ R-M $\bigcirc\bigcirc$ has a possibility that a tool may be damaged. Please adjust a cutting condition with reference to the diagram of P15.
 ③Please refer to the D4 table for the combination of modular mill and carbide shank.
 ④Do not apply lubricants such as grease, etc. to the "contact faces" and "modular screws" of the "modular mill", "dedicated shanks" and "dedicated arbor".
 ⑤When*1 and carbide shank are used together as a set, there is no interference.

Bore type

AHUB15 $\bigcirc\bigcirc\bigcirc\bigcirc$ R(M)- \bigcirc

Numeric figure in a circle \bigcirc .

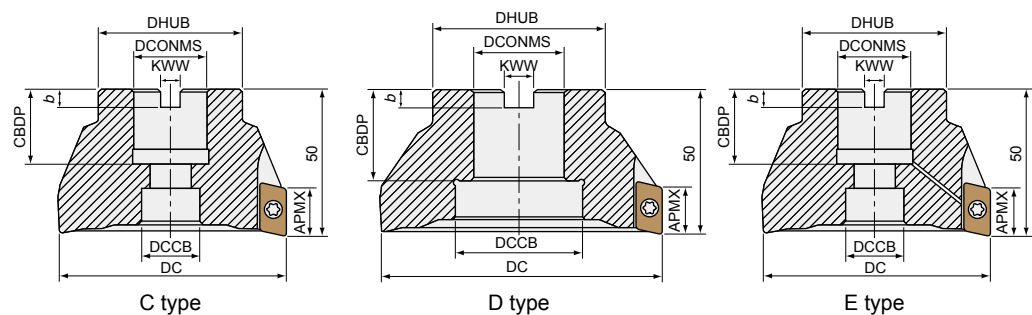

Item code	Stock	No. of flutes	Size(mm)								Shape	Inserts
			DC	APMX	DCONMS	DCCB	DHUB	CBBDP	KWWW	b		
AHUB1550R-3	●	3	50	14 (7)*	22.225	17	47	20	8.4	5	E	JDMT1505 $\bigcirc\bigcirc$ R JDMT1505 $\bigcirc\bigcirc$ R-FW JDMT150508R-TFW JDMT1505 $\bigcirc\bigcirc$ R-B7/C7* JDET1505 $\bigcirc\bigcirc$ R-FF JDET1505 $\bigcirc\bigcirc$ R-FA
AHUB1550R-5	●	5	50		22.225	17	47	20	8.4	5	C	
AHUB1550RM-3	●	3	50		22	17	47	20	10.4	6.3	E	
AHUB1550RM-5	●	5	50		22	17	47	20	10.4	6.3	C	
AHUB1563R-3	●	3	63		22.225	17	45	20	8.4	5	E	
AHUB1563R-6	●	6	63		22.225	17	45	20	8.4	5	C	
AHUB1563RM-3	●	3	63		22	17	45	20	10.4	6.3	E	
AHUB1563RM-6	●	6	63		22	17	45	20	10.4	6.3	C	
AHUB1580R-4	●	4	80		25.4	20	50	26	9.5	6	E	
AHUB1580R-7	●	7	80		25.4	20	50	26	9.5	6	C	
AHUB15100R-8	●	8	100		31.75	45	60	32	12.7	8	D	

- [Note] The arbor screw for attaching the cutter is included with the cutter body of C type and E type.
 * The APMX in the case of using JDMT1505 $\bigcirc\bigcirc$ R-B7/C7 is a value shown in ().

Inserts

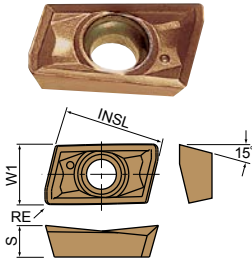

	FW, FF, Conventional (M-class)(E-class)	TFW type (M-class)	FA type (E-class)	B5/B7 type (M-class)	C5/C7 type (M-class)
Insert cross-section shape	Fig.1	Fig.2	Sharp edge Fig.3	Positive land (Large rake) Fig.4	Positive land (Small rake) Fig.5
Application	General purpose	Forged surface cutting; Strong intermittent cutting	Aluminum use	Stainless steels (Wet cutting) Titanium, Nickel based alloy use	Stainless steels (Dry cutting) Nickel based alloy use

[Note] When using the insert with Radius bigger than R2.0, it is necessary to carry out additional cutting of cutter body corner part.

Item code	Tolerance class	AJ Coating		GX Coating	JS Coating		TH Coating			DLC Coating	HD Coating	Carbide	Size(mm)				Insert cross-section shape						
		JP4120	JM4160	GX2160	JS4045	JS4060	PTH30E	PTH40H	PTH13S	SD5010	HD7010	WH10	INSL	W1	S	RE							
JDMT100304R	M	●			●	●	●		●				11	6.1	3.5	0.4	Fig.1						
JDMT100308R		●			●	●	●	●								0.8							
JDMT100320R		●			●	●	●									2.0							
JDMT100332R		●	●		●	●	●									3.2							
JDMT100304R-FW		●			●	●	●									0.4							
JDMT100308R-FW		●	●		●	●	●									0.8							
JDMT100308R-B5		● ^{#1}	●						-	-	-	-				0.8		Fig.4					
JDMT100308R-C5		● ^{#2}		●					-	-	-	-				0.8		Fig.5					
JDMT100320R-B5		● ^{#1}	●						-	-	-	-				2.0		Fig.4					
JDMT100320R-C5		● ^{#2}		●					-	-	-	-				2.0		Fig.5					
JDMT100330R-B5		● ^{#1}	●						-	-	-	-				3.0		Fig.4					
JDMT100330R-C5		● ^{#2}		●					-	-	-	-				3.0		Fig.5					
JDMT100332R-B5		● ^{#1}	●						-	-	-	-				3.2		Fig.4					
JDMT100332R-C5		● ^{#2}		●					-	-	-	-				3.2		Fig.5					
JDMT150504R		●				●	●	●										0.4	16	9.12	5	0.4	Fig.1
JDMT150508R		●			●	●	●	●								0.8							
JDMT150520R		●			●	●	●									2.0							
JDMT150530R		●			●	●	●	●								3.0							
JDMT150504R-FW		●			●	●	●									0.4							
JDMT150508R-FW		●	●		●	●	●									0.8							
JDMT150508R-TFW	●	●		●	●	●						0.8	Fig.2										
JDMT150508R-B7	● ^{#1}	●						-	-	-	-	0.8	Fig.4										
JDMT150508R-C7	● ^{#2}		●					-	-	-	-	0.8	Fig.5										
JDMT150520R-B7	● ^{#1}	●						-	-	-	-	2.0	Fig.4										
JDMT150520R-C7	● ^{#2}		●					-	-	-	-	2.0	Fig.5										
JDMT150530R-B7	● ^{#1}	●						-	-	-	-	3.0	Fig.4										
JDMT150530R-C7	● ^{#2}		●					-	-	-	-	3.0	Fig.5										
JDET100304R-FF	E				●	●				●	-	11	6.1	3.5	0.4	Fig.1							
JDET100308R-FF					●	●				●	-				0.8								
JDET150504R-FF					●	●					●	-	16	9.12	5	0.4							
JDET150508R-FF					●	●					●	-				0.8							
JDET100304R-FA		-	-	-	-	-	-	-		●		●	11	6.1	3.5	0.4	Fig.3						
JDET150502R-FA		-	-	-	-	-	-	-		●		●				0.2							
JDET150504R-FA		-	-	-	-	-	-	-		●		●	16	9.12	5	0.4							
JDET150530R-FA		-	-	-	-	-	-	-		●		●				3.0							

※1 For JDMT○○○○○○R-B○: JP4120, the primary recommended work material is S (titanium alloys) and the secondary recommended work material M (stainless-steel; semi-finishing).
 ※2 For JDMT○○○○○○R-C○: JP4120, the primary recommended work material is S (Ni-based alloys) and the secondary recommended work material is P (carbon steel).
 ※3 The stated recommended work materials are general criteria. In actual use, suitable recommended materials may be different depending on the cutting situation.

[Note] Please note that the GX Coating and JS Coating do not cause a reaction in conductive touch sensors.

Line Up

The Shanks for Modular Mill

Carbide Shank

C type

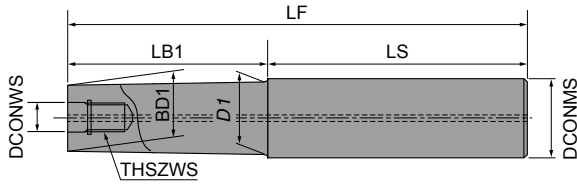

E type

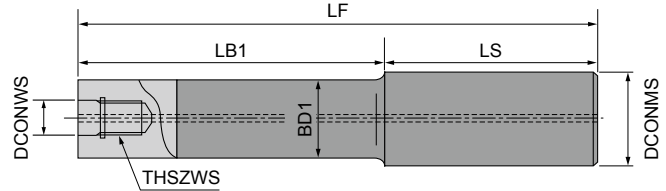

Item code	Stock	Size(mm)								Type	Cutter body	Note
		DCONWS	THSZWS	LF	LB1	LS	BD1	DCONMS	D1			
ASC16-8.5-95-30Z	●	8.5	M8	95	30	65	14.5	16	15.5	C	φ16 ^{※3} φ18 AHUM 1020R-2-M8	With Air hole
ASC16-8.5-120-55Z	●			120	55	65						
ASC16-8.5-140-75Z	●			140	75	65						
ASC16-8.5-160-95Z	●			160	95	65						
※2 ASC16-8.5-160-30Z	●			160	30	130						
ASC20-10.5-120-50Z	●	10.5	M10	120	50	70	18.5	20	19.5	C	φ20 ^{※3} φ22 AHUM 1025R-2-M10	
ASC20-10.5-170-90Z	●			170	90	80						
ASC20-10.5-220-120Z	●			220	120	100						
ASC20-10.5-270-150Z	●			270	150	120						
※2 ASC20-10.5-220-50Z	●	10.5	M10	220	50	170	18.5	20	19.5	C		
※2 ASC20-10.5-270-50Z	●			270		220						
ASC25-12.5-145-65	●	12.5	M12	145	65	80	23	25	-	E	φ25 ^{※3} φ28 AHUM 1030R-2-M12	
ASC25-12.5-215-115	●			215	115	100						
ASC25-12.5-265-145	●			265	145	120						
ASC25-12.5-315-195	●			315	195	120						
※2 ASC25-12.5-265-65	●	12.5	M12	265	65	200	23	25	-	E	AHUM 1530R-2-M12	
※2 ASC25-12.5-315-65	●			315		250						
ASC32-17-160-80	●	17	M16	160	80	80	28	32	-	E	φ30 ^{※3} φ32 ^{※3} φ35 (φ40)	
ASC32-17-210-110	●			210	110	100						
ASC32-17-260-140	●			260	140	120						
ASC32-17-310-190	●			310	190	120						
ASC32-17-360-240	●			360	240	120						
※2 ASC32-17-260-80	●	17	M16	260	80	180	28	32	-	E		
※2 ASC32-17-310-80	●			310		230						
※2 ASC32-17-360-80	●			360		280						

[Note]

- ① When ※2 and ※1 (p. 6) are used together as a set, there is no interference.
- ② Commercial milling chucks or shrink-fit holders can be used.
- ③ For the φ40 size, it is recommended that the protrusion length be 200mm or less.
- ④ For ※3, since the cutter diameter is smaller than the shank diameter, interference occurs at the shank.

Steel Shank

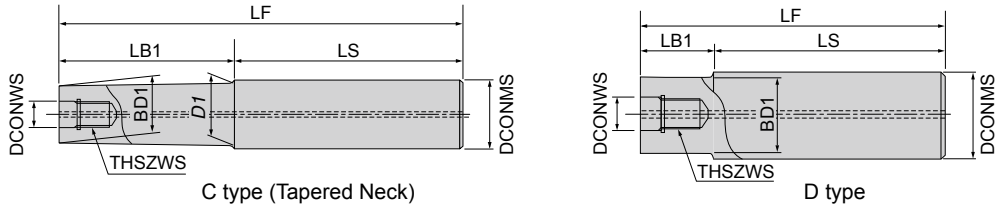

Item code	Stock	Size (mm)								Type	Cutter body	Note
		DCONWS	THSZWS	LF	LB1	LS	BD1	DCONMS	D1			
AS16-8.5-95-15	●	8.5	M8	95	15	80	14.5	16	15.5	C	φ16 ^{*3} , φ18 AHUM1020R-2-M8	With Air hole
AS20-10.5-100-20	●	10.5	M10	100	20	80	18	20	—	D	φ20 ^{*3} , φ22 AHUM1025R-2-M10	
AS25-12.5-115-35	●	12.5	M12	115	35	80	23	25	—	D	φ25 ^{*3} , φ28 AHUM1030R-2-M12 AHUM1530R-2-M12	
AS32-17-110-30	●	17	M16	110	30	80	28	32	—	D	φ30 ^{*3} , φ32 ^{*3} φ35, φ40	

[Note] ① Commercial milling chucks can be used. ② For ^{*3}, since the cutter diameter is smaller than the shank diameter, interference occurs at the shank.

Steel Shank

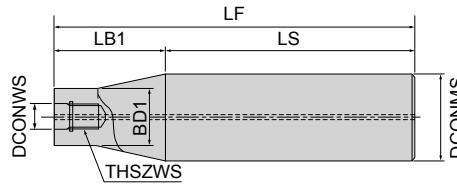

※ For neck section or total length, additional machining to user specifications is possible.

Item code	Stock	Size (mm)							Cutter body	Note
		DCONWS	THSZWS	LF	LB1	LS	BD1	DCONMS		
AS42-17-360-90	●	17	M16	360	90	270	28	42	φ30, φ32, φ35, φ40	With Air hole

[Note] Commercial milling chucks can be used.

Modular Mill Arbor

HSK - A63

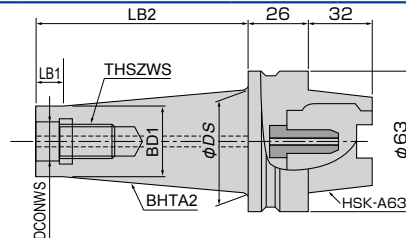

Item code	Stock	Size (mm)							Note
		DCONWS	THSZWS	BD1	φDS	LB2	LB1	BHTA2	
HSK-A63-10.5-30-18	●	10.5	10	18	20.8	30	-	3°	With Air hole
HSK-A63-10.5-70-18	●				25	70	10	3°	
HSK-A63-10.5-70-18S					48	70	10	12°	
HSK-A63-10.5-120-18	●	30.2	120	10	3°				
HSK-A63-12.5-35-21	●	12.5	12	21	24.3	35	-	3°	
HSK-A63-12.5-65-21	●				27.5	65	10	3°	
HSK-A63-12.5-65-21S					48	65	10	12°	
HSK-A63-12.5-115-21	●	32.7	115	10	3°				
HSK-A63-17-40-28	●	17	16	28	31.8	40	-	3°	
HSK-A63-17-60-28	●				33.9	60	10	3°	
HSK-A63-17-60-28S					48	60	10	9.5°	
HSK-A63-17-110-28	●	39.2	110	10	3°				

[Note] Coolant Pipe is attached.

Arbor (BT, HSK) Features

Point

Reduce the chattering vibration by BT, HSK arbor due to the reduction in the "actual" overhang.

Figure Example : Overhang and Application Area

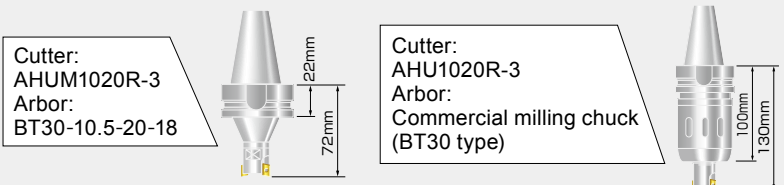

Line Up

Red screw arbor

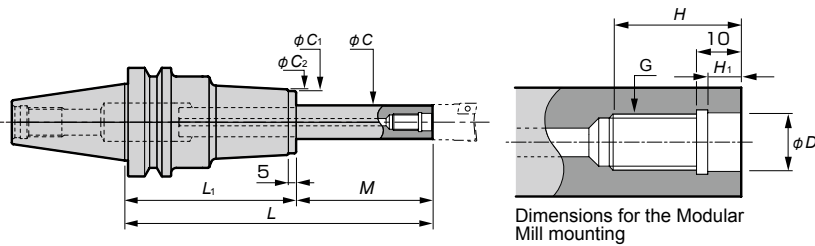

Dimensions for the Modular Mill mounting

Caution

- Some of the indexable end mills cannot be attached to the RED screw arbor. Please check your indexable end mills for conformance to the dimensions, or please contact MOLDINO Tool Engineering, Ltd.
- Because cutting resistance is greater than the tool holder connection force associated with the machine spindle, please reduce the recommended cutting conditions by 50% for the RED screw arbors marked with ※. Otherwise, the tool holder shank may experience fretting corrosion or fall out of the machine spindle.

Item code	Stock	Size(mm)										Weight (kg)	Rigidity value (μm) ↓			
		G	φD	H	H ₁	φC	L	M	L ₁	φC ₁	φC ₂					
BT40-RSG8-105-M25							105				80				1.4	0.6
BT40-RSG8-135-M25							135	25			110				1.8	0.7
BT40-RSG8-165-M25							165				140				2.1	0.8
BT40-RSG8-130-M50							130				80				1.4	1.5
BT40-RSG8-160-M50							160	50			110				1.8	1.7
BT40-RSG8-190-M50							190				140				2.1	1.8
BT40-RSG8-155-M75							155				80				1.5	3.1
BT40-RSG8-185-M75		M8	8.5	18	6.5	15	185	75			110	30	32		1.9	3.4
BT40-RSG8-215-M75							215				140				2.2	3.5
BT40-RSG8-170-M90							170				140				1.5	4.5
BT40-RSG8-200-M90							200	90			110				1.9	4.8
BT40-RSG8-230-M90							230				140				2.2	4.9
BT40-RSG8-185-M105							185				80				1.6	6.2
BT40-RSG8-215-M105							215	105			110				2.0	6.7
BT40-RSG8-245-M105							245				140				2.3	6.8
BT40-RSG10-125-M25							125				100				1.8	0.4
BT40-RSG10-155-M25							155	25			130				2.2	0.5
BT40-RSG10-185-M25							185				160				2.4	0.7
BT40-RSG10-150-M50							150				100				1.9	0.8
BT40-RSG10-180-M50							180	50			130				2.3	1.0
BT40-RSG10-210-M50							210				160				2.5	1.2
BT40-RSG10-175-M75							175				100				2.0	1.6
BT40-RSG10-205-M75		M10	10.5	22	6.5	19	205	75			130	36	38		2.4	1.8
BT40-RSG10-235-M75							235				160				2.6	2.0
BT40-RSG10-200-M100							200				100				2.0	2.7
BT40-RSG10-230-M100							230	100			130				2.4	3.0
BT40-RSG10-260-M100							260				160				2.6	3.3
BT40-RSG10-220-M120							220				100				2.1	4.0
BT40-RSG10-250-M120							250	120			130				2.5	4.3
BT40-RSG10-280-M120							280				160				2.7	4.6
BT40-RSG12-125-M25							125				100				2.0	0.3
BT40-RSG12-155-M25							155	25			130				2.4	0.4
BT40-RSG12-185-M25							185				160				2.7	0.5
BT40-RSG12-150-M50							150				100				2.1	0.5
BT40-RSG12-180-M50							180	50			130				2.5	0.7
BT40-RSG12-210-M50							210				160				2.8	0.9
BT40-RSG12-175-M75							175				100				2.3	0.9
BT40-RSG12-205-M75		M12	12.5	22	6	24	205	75			130	43	45		2.7	1.1
BT40-RSG12-235-M75							235				160				3.0	1.3
BT40-RSG12-200-M100							200				100				2.4	1.4
BT40-RSG12-230-M100							230	100			130				2.8	1.6
BT40-RSG12-260-M100							260				160				3.1	1.9
BT40-RSG12-225-M125							225				100				2.6	2.1
BT40-RSG12-255-M125							255	125			130				3.0	2.4
BT40-RSG12-285-M125							285				160				3.3	2.8
BT40-RSG16-125-M25							125	25							2.6	0.2
BT40-RSG16-150-M50							150	50							2.8	0.3
BT40-RSG16-175-M75		M16	17	25	6	29	175	75			100	52	54		3.0	0.5
BT40-RSG16-200-M100							200				100				3.2	0.8
BT40-RSG16-225-M125 ※							225	125							3.4	1.2
BT50-RSG8-120-M25							120				95				4.0	0.6
BT50-RSG8-150-M25							150	25			125				4.3	0.7
BT50-RSG8-180-M25							180				155				4.8	0.7
BT50-RSG8-145-M50							145				95				4.0	1.5
BT50-RSG8-175-M50							175	50			125				4.3	1.7
BT50-RSG8-205-M50							205				155				4.8	1.7
BT50-RSG8-170-M75							170				95				4.1	3.1
BT50-RSG8-200-M75		M8	8.5	18	6.5	15	200	75			125	30	32		4.4	3.4
BT50-RSG8-230-M75							230				155				4.9	3.4
BT50-RSG8-185-M90							185				155				4.9	4.4
BT50-RSG8-215-M90							215	90			125				4.4	4.8
BT50-RSG8-245-M90							245				155				4.9	4.8
BT50-RSG8-200-M105							200				95				4.2	6.2
BT50-RSG8-230-M105							230	105			125				4.5	6.6
BT50-RSG8-260-M105							260				155				5.0	6.6
BT50-RSG10-140-M25							140				115				4.3	0.4
BT50-RSG10-170-M25		M10	10.5	22	6.5	19	170	25			145	36	38		4.6	0.5
BT50-RSG10-200-M25							200				175				5.6	0.5
BT50-RSG10-165-M50							165				115				4.4	0.8
BT50-RSG10-195-M50							195	50			145				4.7	0.9
BT50-RSG10-225-M50							225				175				5.7	1.0
BT50-RSG10-190-M75							190				115				4.5	1.6
BT50-RSG10-220-M75							220	75			145				4.8	1.7
BT50-RSG10-250-M75							250				175				5.8	1.8
BT50-RSG10-215-M100							215				115				4.5	2.7
BT50-RSG10-245-M100		M10	10.5	22	6.5	19	245	100			145	36	38		4.8	2.9
BT50-RSG10-275-M100							275				175				5.8	2.9
BT50-RSG10-235-M120							235				115				4.6	3.9
BT50-RSG10-265-M120							265	120			145				4.9	4.2
BT50-RSG10-295-M120							295				175				5.9	4.2
BT50-RSG10-255-M140							255				115				4.7	5.5
BT50-RSG10-285-M140							285	140			145				5.0	5.8
BT50-RSG10-315-M140							315				175				6.0	5.8
BT50-RSG12-140-M25							140				115				4.6	0.2
BT50-RSG12-170-M25							170	25			145				5.0	0.3
BT50-RSG12-200-M25							200				175				5.8	0.4
BT50-RSG12-165-M50							165				115				4.7	0.5
BT50-RSG12-195-M50							195	50			145				5.1	0.6
BT50-RSG12-225-M50							225				175				5.9	0.6
BT50-RSG12-190-M75							190				115				4.9	0.8
BT50-RSG12-220-M75							220	75			145				5.3	1.0
BT50-RSG12-250-M75							250				175				6.1	1.0
BT50-RSG12-215-M100							215				115				5.0	1.3
BT50-RSG12-245-M100		M12	12.5	22	6	24	245	100			145	43	45		5.4	1.5
BT50-RSG12-275-M100							275				175				6.2	1.6
BT50-RSG12-240-M125							240				115				5.2	2.1
BT50-RSG12-270-M125							270	125			145				5.6	2.3
BT50-RSG12-300-M125							300				175				6.4	2.4
BT50-RSG12-265-M150							265				115				5.3	3.0
BT50-RSG12-295-M150							295	150			145				5.7	3.3
BT50-RSG12-325-M150							325				175				6.5	3.4
BT50-RSG12-290-M175							290				115				5.5	4.2
BT50-RSG12-320-M175							320	175			145				5.9	4.6
BT50-RSG12-350-M175							350				175				6.7	4.6
BT50-RSG16-140-M25							140				115				4.8	0.2
BT50-RSG16-170-M25							170	25			145				5.4	0.2
BT50-RSG16-200-M25							200				175				6.6	0.2
BT50-RSG16-165-M50							165				115				5.0	0.3
BT50-RSG16-195-M50							195	50			145				5.6	0.4
BT50-RSG16-225-M50							225				175				6.8	0.4

Recommended Cutting Conditions

Red indicates primary recommended grade.

Work material	Recommended grade	Cutting conditions	Tool dia. DC							
			AHU/AHUM 10 type							
			Φ16-2 flutes		Φ20-3 flutes		Φ25-4 flutes		Φ32-5 flutes	
			Revolution min ⁻¹	Feed speed (mm/min)	Revolution min ⁻¹	Feed speed (mm/min)	Revolution min ⁻¹	Feed speed (mm/min)	Revolution min ⁻¹	Feed speed (mm/min)
Mild steels SS	JS4060	Revolution <i>n</i> / Feed speed <i>V_f</i>	3,180	570	2,390	1,080	1,910	1,150	1,490	1,120
		Cutting Speed <i>V_c</i> (m/min)	120 ~ 200 (160)				120 ~ 180 (150)			
		Feed Rate <i>f_z</i> (mm/t)	0.06 ~ 0.12 (0.09)				0.1 ~ 0.2 (0.15)			
Carbon steels & Alloy steels S-C, SCM	JS4060 JS4045	Revolution <i>n</i> / Feed speed <i>V_f</i>	3,180	450	2,390	1,000	1,910	1,070	1,490	1,040
		Cutting Speed <i>V_c</i> (m/min)	120 ~ 200 (160)				120 ~ 180 (150)			
		Feed Rate <i>f_z</i> (mm/t)	0.05 ~ 0.1 (0.07)				0.08 ~ 0.2 (0.14)			
Die steels (300HB or less) SKD, SKT	JS4060 JS4045	Revolution <i>n</i> / Feed speed <i>V_f</i>	2,980	420	2,230	940	1,780	1,000	1,390	970
		Cutting Speed <i>V_c</i> (m/min)	120 ~ 180 (150)				120 ~ 160 (140)			
		Feed Rate <i>f_z</i> (mm/t)	0.05 ~ 0.1 (0.07)				0.08 ~ 0.2 (0.14)			
Pre-hardened steels (30~40HRC)	JP4120	Revolution <i>n</i> / Feed speed <i>V_f</i>	1,990	280	1,590	670	1,270	710	990	700
		Cutting Speed <i>V_c</i> (m/min)	80 ~ 120 (100)				80 ~ 120 (100)			
		Feed Rate <i>f_z</i> (mm/t)	0.05 ~ 0.1 (0.07)				0.08 ~ 0.2 (0.14)			
Stainless steels (Dry Cutting) SUS	GX2160 JM4160	Revolution <i>n</i> / Feed speed <i>V_f</i>	4,970	1,190	3,980	2,030	3,180	2,160	2,490	2,110
		Cutting Speed <i>V_c</i> (m/min)	200 ~ 300 (250)				200 ~ 300 (250)			
		Feed Rate <i>f_z</i> (mm/t)	0.1 ~ 0.15 (0.12)				0.15 ~ 0.2 (0.17)			
Stainless steels (Wet Cutting) SUS	JM4160 PTH30E	Revolution <i>n</i> / Feed speed <i>V_f</i>	1,990	480	1,590	810	1,270	870	990	850
		Cutting Speed <i>V_c</i> (m/min)	80 ~ 120 (100)				80 ~ 120 (100)			
		Feed Rate <i>f_z</i> (mm/t)	0.1 ~ 0.15 (0.12)				0.15 ~ 0.2 (0.17)			
Cast irons FC, FCD	PTH13S JP4120	Revolution <i>n</i> / Feed speed <i>V_f</i>	2,980	540	2,230	1,000	1,780	1,070	1,390	1,040
		Cutting Speed <i>V_c</i> (m/min)	120 ~ 180 (150)				120 ~ 160 (140)			
		Feed Rate <i>f_z</i> (mm/t)	0.06 ~ 0.12 (0.09)				0.1 ~ 0.2 (0.15)			
Aluminum alloys (wet condition)	WH10 SD5010	Revolution <i>n</i> / Feed speed <i>V_f</i>	6,960	1,670	6,370	2,860	5,090	3,060	3,980	2,980
		Cutting Speed <i>V_c</i> (m/min)	200 ~ 500 (350)				200 ~ 600 (400)			
		Feed Rate <i>f_z</i> (mm/t)	0.1 ~ 0.15 (0.12)				0.1 ~ 0.2 (0.15)			
Titanium alloys (wet condition) Ti-6Al-4V	JP4120 PTH30E	Revolution <i>n</i> / Feed speed <i>V_f</i>	900	160	720	320	570	340	450	340
		Cutting Speed <i>V_c</i> (m/min)	30 ~ 60 (45)				30 ~ 60 (45)			
		Feed Rate <i>f_z</i> (mm/t)	0.08 ~ 0.1 (0.09)				0.1 ~ 0.2 (0.15)			
Ni based alloys (wet condition)	JP4120 JM4160	Revolution <i>n</i> / Feed speed <i>V_f</i>	800	160	640	190	510	200	400	200
		Cutting Speed <i>V_c</i> (m/min)	30 ~ 50 (40)				30 ~ 50 (40)			
		Feed Rate <i>f_z</i> (mm/t)	0.07 ~ 0.13 (0.1)				0.07 ~ 0.13 (0.1)			

[Note] Please note that the GX Coating and JS Coating do not cause a reaction in conductive touch sensors.

Adjustment of cutting conditions

- Feed rate and spindle revolution must be adjusted to correspond to tool overhang and machining conditions.
- Please consider the standard cutting conditions as 100% and adjust the machining conditions by referring to the table below.

		Overhang		
		<3DC	3DC~5DC	5DC<
Surfacing Shoulder milling	Rotation speed <i>n</i>	100%	70%	50%
	Feed rate <i>V_f</i>	100%	70%	50%
Slotting	Rotation speed <i>n</i>	100%	70%	50%
	Feed rate <i>V_f</i>	70%	50%	35%
Ramping	Rotation speed <i>n</i>	100%	70%	50%
	Feed rate <i>V_f</i>	80%	55%	40%

Tool dia. DC														Work material
AHU/AHUM/AHUB 15 type														
Φ25-2 flutes		Φ32-3 flutes		Φ40-4 flutes		Φ50-5 flutes		Φ63-6 flutes		Φ80-7 flutes		Φ100-8 flutes		
Revolution min ⁻¹	Feed speed (mm/min)	Revolution min ⁻¹	Feed speed (mm/min)	Revolution min ⁻¹	Feed speed (mm/min)	Revolution min ⁻¹	Feed speed (mm/min)	Revolution min ⁻¹	Feed speed (mm/min)	Revolution min ⁻¹	Feed speed (mm/min)	Revolution min ⁻¹	Feed speed (mm/min)	
1,910	760	1,490	900	1,190	950	950	950	760	910	600	840	480	760	Mild steels SS
120 ~ 180 (150)						120 ~ 180 (150)				120 ~ 180 (150)				
0.15 ~ 0.25 (0.2)														
1,910	760	1,490	900	1,190	950	950	950	760	910	600	840	480	760	Carbon steels & Alloy steels S-C, SCM
120 ~ 180 (150)						120 ~ 180 (150)				120 ~ 180 (150)				
0.15 ~ 0.25 (0.2)														
1,780	530	1,390	630	1,110	670	890	670	710	640	560	580	450	530	Die steels (300HB or less) SKD, SKT
120 ~ 160 (140)						120 ~ 160 (140)				120 ~ 160 (140)				
0.1 ~ 0.2 (0.15)														
1,270	380	990	450	800	480	640	480	510	450	400	420	320	380	Pre-hardened steels (30~40HRC)
80 ~ 120 (100)						80 ~ 120 (100)				80 ~ 120 (100)				
0.1 ~ 0.2 (0.15)														
3,180	1,270	2,490	1,490	1,990	1,590	1,590	1,590	1,260	1,520	990	1,390	760	1,220	Stainless steels (Dry Cutting) SUS
200 ~ 300 (250)						200 ~ 300 (250)				200 ~ 280 (240)				
0.15 ~ 0.25 (0.2)														
1,270	510	990	600	800	640	640	640	510	610	400	560	320	510	Stainless steels (Wet Cutting) SUS
80 ~ 120 (100)						80 ~ 120 (100)				80 ~ 120 (100)				
0.15 ~ 0.25 (0.2)														
1,780	710	1,390	840	1,110	890	890	890	710	850	560	780	450	710	Cast irons FC, FCD
120 ~ 160 (140)						120 ~ 160 (140)				120 ~ 160 (140)				
0.15 ~ 0.25 (0.2)														
5,090	1,730	3,980	2,030	3,180	2,160	2,550	2,160	2,530	2,580	1,990	2,370	1,590	2,160	Aluminum alloys (wet condition)
200 ~ 600 (400)						200 ~ 800 (500)				200 ~ 800 (500)				
0.1 ~ 0.25 (0.17)														
570	170	450	200	360	210	290	210	230	200	180	190	130	150	Titanium alloys (wet condition) Ti-6Al-4V
30 ~ 60 (45)						30 ~ 60 (45)				30 ~ 50 (40)				
0.1 ~ 0.2 (0.15)														
510	100	400	120	320	130	250	130	200	120	160	110	130	100	Ni based alloys (wet condition)
30 ~ 50 (40)						30 ~ 50 (40)				30 ~ 50 (40)				
0.07 ~ 0.13 (0.1)														

Ramping

Although ramp angle is limited due to cutting edge design, direct milling is possible without pre-drill-hole with ramping and helical milling methods like next pictures.

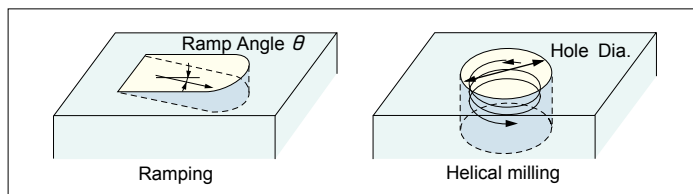

⚠ Attention on Safety

- ① The steel chips may cause cuts, burns or damages to eyes. Be sure to install the safety cover around the tool and wear the safety glasses when carrying out any works.
- ② Do not use non-water-soluble cutting oils. Such oils may result in fire.

① AHU(L)/AHUM 10 type (mm)

Tool dia. DC	φ16	φ20	φ21	φ25	φ26	φ30	φ32	φ35
Maximum ramp angle θ	4°	3°	3°	2.5°	2.5°	2°	2°	1.5°
Hole Dia.	21~29	29~37	31~39	39~47	41~49	49~56	53~61	59~66

② AHU(L)/AHUM 15 type (mm)

Tool dia. DC	φ25	φ30	φ32	φ35	φ40	φ50
Maximum ramp angle θ	5°	4°	4°	3.5°	3°	2°
Hole Dia.	34~47	43~56	47~60	54~66	64~76	83~96

③ AHUB15 type (mm)

Tool dia. DC	φ50	φ63	φ80	φ100
Maximum ramp angle θ	2°	1.5°	1.0°	0.5°
Hole Dia.	83~96	100~116	135~152	168~192

[Note] ① The ramp angle θ should be set within the ranges listed above. Use at ramp angles of 1° or less is recommended. ② For hole diameters outside the ranges listed above, a pilot hole should be drilled before milling.

Recommended Cutting Conditions

○ Cutting conditions for cutting aluminum alloy and copper using SD5010

<Shoulder cutting> : **$a_e=0.5DC$**

Work material	Cutting conditions	AHU/AHUM 10 type					AHU/AHUB/AHUM 15 type							
		Φ16 2 Flutes	Φ20 3 Flutes	Φ25 4 Flutes	Φ32 5 Flutes	Φ35 5 Flutes	Φ25 2 Flutes	Φ32 3 Flutes	Φ35 3 Flutes	Φ40 4 Flutes	Φ50 5 Flutes	Φ63 6 Flutes	Φ80 7 Flutes	Φ100 8 Flutes
Expanded aluminum alloy material A5052, A7075 etc. (Air-blow or wet: Water-soluble agent)	Revolution n (min ⁻¹)	15,900	15,900	12,700	11,900	10,910	12,000	9,950	9,090	9,500	7,640	6,060	5,970	4,770
	Cutting speed v_c (m/min)	800	1,000	1,000	1,200	1,200	950	1,000	1,000	1,200	1,200	1,200	1,500	1,500
	Feed speed v_f (mm/min)	4,770	7,150	7,620	8,920	8,180	4,800	5,970	5,450	7,600	7,640	7,270	8,360	7,630
	Feed rate f_z (mm/t)	0.15	0.15	0.15	0.15	0.15	0.2	0.2	0.2	0.2	0.2	0.2	0.2	0.2
	Axial depth of cut a_p (mm)	3	3	3	3	3	5	5	5	5	5	5	5	5
Cast aluminum alloy material AC4A, ADC12 etc. (Air-blow or wet: Water-soluble agent)	Revolution n (min ⁻¹)	12,700	12,700	10,160	9,520	8,730	9,600	7,960	7,270	7,600	6,110	4,850	4,780	3,820
	Cutting speed v_c (m/min)	640	800	800	960	960	760	800	800	960	960	960	1,200	1,200
	Feed speed v_f (mm/min)	3,820	5,720	6,100	7,140	6,550	3,840	4,780	4,360	6,080	6,110	5,820	6,690	6,100
	Feed rate f_z (mm/t)	0.15	0.15	0.15	0.15	0.15	0.2	0.2	0.2	0.2	0.2	0.2	0.2	0.2
	Axial depth of cut a_p (mm)	3	3	3	3	3	5	5	5	5	5	5	5	5
Pure copper C1100, C1020 etc. (Wet: Water-soluble agent)	Revolution n (min ⁻¹)	5,970	4,770	3,820	2,980	2,730	3,820	2,980	2,730	2,390	1,910	1,520	1,190	955
	Cutting speed v_c (m/min)	300	300	300	300	300	300	300	300	300	300	300	300	300
	Feed speed v_f (mm/min)	1,790	2,150	2,290	2,240	2,050	1,530	1,790	1,640	1,910	1,910	1,820	1,670	1,530
	Feed rate f_z (mm/t)	0.15	0.15	0.15	0.15	0.15	0.2	0.2	0.2	0.2	0.2	0.2	0.2	0.2
	Axial depth of cut a_p (mm)	3	3	3	3	3	5	5	5	5	5	5	5	5

- [Note] ① Use the appropriate coolant for the work material and machining shape.
 ② These conditions are for general guidance; in actual machining conditions adjust the parameters according to your actual machine and work-piece conditions.
 ③ When cutting grooves, reduce the feed rate by 30% (set it to 0.7 times the value shown above).
 ④ When L/D = 4 or higher, reduce the rotation speed and feed rate by 60% (set them to 0.4 times the values shown above).
 ⑤ Use on a machine equipped with splashguards. During use, be sure to wear protective equipment such as safety glasses, and always perform work in a safe environment.
 ⑥ When using a machine that cannot provide the rotation speed shown above, set the highest rotation speed possible and calculate the feed rate using the f_z value.
 ⑦ Be sure to use this tool at rotation speeds within the acceptable range for the milling chuck being used. If the acceptable rotation speed range is below the rotation speed shown above, set the highest acceptable rotation speed and calculate the feed rate using the f_z value.

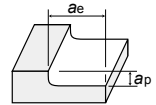

○ Cutting conditions for cutting graphite and cast aluminium alloy

Work material	Recommended grade	Cutting conditions	AHU/AHUM 10 type		AHU/AHUB/AHUM 15 type		
			Φ16	Φ20~35	Φ25~50	Φ63~80	Φ100
Graphite	HD7010	Cutting speed V_c (m/min)	150~300	150~300	150~300	150~300	150~300
		Feed rate f_z (mm/t)	0.10~0.20	0.10~0.20	0.1~0.25	0.1~0.25	0.1~0.25
Cast aluminum alloy AC4A, ADC12 etc (Air-blow or wet: water-soluble agent)	HD7010	Cutting speed V_c (m/min)	200~500	200~500	200~600	200~600	200~600
		Feed rate f_z (mm/t)	0.10~0.20	0.10~0.20	0.1~0.25	0.1~0.25	0.1~0.25

- [Note] ① Use the appropriate coolant for the work material and machining shape.
 ② These conditions are for general guidance; in actual machining conditions adjust the parameters according to your actual machine and work-piece conditions.
 ③ Since there is a danger of breakage when using this tool, be sure to use the cutting area cover, protective goggles, safety shoes, etc.

Overhang and Cutting Area

• Cutting Speed : $V_c=120\text{m/min}$ • Work material : S50C(220HB) • Machine : BT50 M/C

AHU (L) 10 type		AHU (L) 15 type	
<p>$\phi 16$ $f_z=0.1$ (mm/t)</p>	<p>Overhang: 2DC AHU1016R-2 Overhang: 3DC, 4DC AHUL1016R-2 DC: Tool Dia.</p>	<p>$\phi 25$ $f_z=0.15$ (mm/t)</p>	<p>Overhang: 3DC AHU1525R-2 Overhang: 4DC AHUL1525R-2 DC: Tool Dia.</p>
<p>$\phi 20$ $f_z=0.15$ (mm/t)</p>	<p>Overhang: 2DC, 3DC AHU1020R-3 Overhang: 4DC, 5DC AHUL1020R-3 DC: Tool Dia.</p>	<p>$\phi 32$ $f_z=0.15$ (mm/t)</p>	<p>Overhang: 1.4DC AHU1532R-3 Overhang: 3DC, 4DC AHUL1532R-3 DC: Tool Dia.</p>
<p>$\phi 25$ $f_z=0.15$ (mm/t)</p>	<p>Overhang: 3DC AHU1025R-4 Overhang: 4DC AHUL1025R-3 DC: Tool Dia.</p>	<p>$\phi 40$ $f_z=0.15$ (mm/t)</p>	<p>Overhang: 1.5DC, 2DC AHU1540R-4 Overhang: 3DC AHUL1540R-4 DC: Tool Dia.</p>
<p>$\phi 32$ $f_z=0.15$ (mm/t)</p>	<p>Overhang: 3DC AHU1032R-5 Overhang: 4DC AHUL1032R-4 DC: Tool Dia.</p>	<p>$\phi 50$ $f_z=0.15$ (mm/t)</p>	<p>Overhang: 2DC AHU1550R-5 Overhang: 3DC AHUL1550R-4 DC: Tool Dia.</p>

[Note] Please adjust the cutting condition with reference to the above-stated graph depending on the stiffness of a work piece or a machine.

Cutting area of modular mill

• Work material : S50C(220HB) • Cutting Speed : $V_c=100\text{m/min}$
• Feed rate : $f_z=0.1\text{mm/t}$ • Machine : BT50

Overhang 120mm		Overhang 150mm		Overhang 200mm	
<p>$\phi 16$</p>	<p>$\phi 20$</p>	<p>$\phi 25$</p>	<p>$\phi 20$</p>	<p>$\phi 25$</p>	<p>$\phi 30$</p>

[Note] Please adjust the cutting condition with reference to the above-stated graph depending on the stiffness of a work piece or a machine.



The diagrams and table data are examples of test results, and are not guaranteed values.
 "MOLDINO" is a registered trademark of MOLDINO Tool Engineering, Ltd.



Attentions on Safety

1. Attentions regarding handling

- (1) When removing the tool from the case (package), be careful not to drop it on your foot or drop it onto the tips of your bare fingers.
- (2) When actually setting the inserts, be careful not to touch the cutting flute directly with your bare hands.

2. Attentions regarding mounting

- (1) When preparing for use, be sure that the inserts are firmly mounted in place and that they are firmly mounted on the arbor, etc.
- (2) If abnormal chattering occurs during use, stop the machine immediately and remove the cause of the chattering.

3. Attentions during use

- (1) Before use, confirm the dimensions and direction of rotation of the tool and milling work material.
- (2) The numerical values in the standard cutting conditions table should be used as criteria when starting new work. The cutting conditions should be adjusted as appropriate when the cutting depth is large, the rigidity of the machine being used is low, or according to the conditions of the work material.
- (3) The inserts are made of a hard material. During use, they may break and fly off. In addition, cutting chips may also fly off. Since there is a danger of injury to workers, fire, or eye damage from such flying pieces, a safety cover should be installed and safety equipment such as safety glasses should be worn to create a safe environment for work.
 - Do not use where there is a risk of fire or explosion.
 - Do not use non-water-soluble cutting oils. Such oils may result in fire.
- (4) Do not use the tool for any purpose other than that for which it is intended, and do not modify it.

MOLDINO Tool Engineering, Ltd.

Head Office
 Hulic Ryogoku Bldg. 8F, 4-31-11, Ryogoku, Sumida-ku, Tokyo, Japan 130-0026
 International Sales Dept. : TEL +81-3-6890-5103 FAX +81-3-6890-5128

Official Web Site

<http://www.moldino.com/en/>

Database for selection Cutting Tool Products [TOOL SEARCH]

Europe

MOLDINO Tool Engineering Europe GmbH

Itterpark 12, 40724 Hilden, Germany
 Tel +49-(0)2103-24820 Fax +49-(0)2103-248230

China

MOLDINO Tool Engineering (Shanghai), Ltd.

Room 2804-2805, Metro Plaza, 555 Loushanguan Road, Changning District, Shanghai, 200051, China
 Tel +86-(0)21-3366-3058 Fax +86-(0)21-3366-3050

America

MITSUBISHI MATERIALS U.S.A. CORPORATION

DETROIT OFFICE Customer service
 41700 Gardenbrook Road, Suite 120, Novi, MI 48375-1320 U.S.A.
 Tel +1(248) 308-2620 Fax +1(248) 308-2627

Mexico

MMC METAL DE MEXICO, S.A. DE C.V.

Av. La Cañada No.16, Parque Industrial Bernardo Quintana, El Marques, Querétaro, CP 76246, México
 Tel +52-442-1926800

Brazil

MMC METAL DO BRASIL LTDA.

Rua Cincinato Braga, 340 13° andar, Bela Vista – CEP 01333-010 São Paulo – SP., Brasil
 Tel +55(11)3506-5600 Fax +55(11)3506-5677

Thailand

MMC Hardmetal (Thailand) Co.,Ltd. MOLDINO Division

622 Emporium Tower, Floor 22/1-4, Sukhumvit Road, Klong Tan, Klong Toei,
 Bangkok 10110, Thailand
 Tel +66-(0)2-661-8175 Fax +66-(0)2-661-8176

India

MMC Hardmetal India Pvt Ltd.

H.O.: Prasad Enclave, #118/119, 1st Floor, 2nd Stage, 5th main, BBMP Ward #11, (New #38),
 Industrial Suburb, Yeshwanthpura, Bengaluru, 560 022, Karnataka, India.
 Tel +91-80-2204-3600

DISTRIBUTED BY: